



ACT-52HC / ACT-32HC UHF Analog

ACT-24HC 2.4 GHz Digital

ACT-58HC 5.8 GHz Digital

Rechargeable Wireless Microphone

User Guide

ACT-52HC



ACT-32HC



ACT-24HC



ACT-58HC



I. Part Names

ACT-32HC

ACT-24HC

ACT-58HC

ACT-52HC

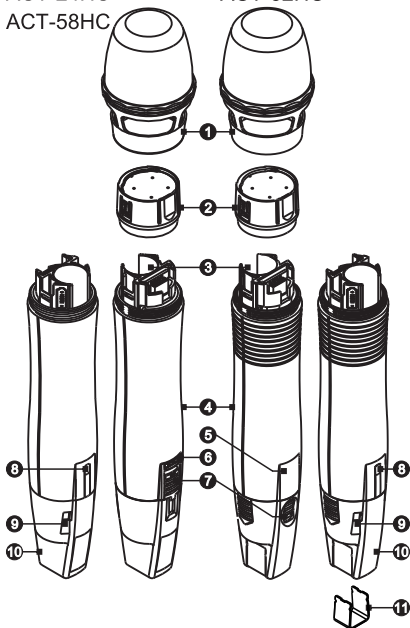

❶ Microphone Capsule Module

❷ Fixed Ring

❸ Battery Compartment

❹ Housing

❺ LCD Screen

❻ Battery Meter Indicators

❼ Power Switch

❽ ACT Sync Window

❾ Battery Charging Contacts

❿ Protection Cover

⓫ Channel ID Clip (Additional)

II. Battery Installation

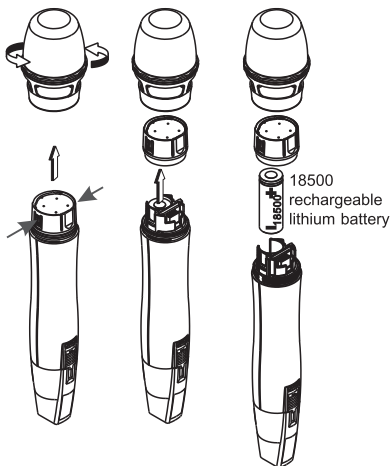

1. Rotate and remove the microphone capsule module ❶ counterclockwise.
2. Press both sides of the Fixed Ring ❷ to pull out Fixed Ring. Insert or remove a 18500 rechargeable battery.
3. Insert a 18500 rechargeable battery with positive + facing up. Put the Fixed Ring back and ensure the hook is positioned and then rotate the capsule module tight.
4. Notice:
 - (A) If inserted with correct polarity and still cannot be powered on, it could be due to battery protection mechanism is activated. Insert the whole transmitter back to the charging station for 10 seconds to deactivate and power on again.

- (B) If the charging station is not used, reverse battery polarity for 10 seconds then re-inserted with correct polarity to wake up the battery. Power on again.

III. Operating Instructions

ACT-32HC / ACT-24HC / ACT-58HC:

1. Power on: Push the Power Switch **7** to ON, the Battery Meter Indicators **6** are lit.
Power off: Push to OFF, the Battery Meter Indicators are dim.
2. Do ACT synchronization according to the operating instructions of the receiver's ACT Set-up.
3. When the microphone catches sounds, the AUDIO signal indicators on the receiver panel will blink. It indicates the wireless transmission between the microphone and the receiver is normal.
4. Battery Level Status: When the battery is in low voltage and the red indicator is lit, it needs to be charged. If low voltage condition continues, it will power off automatically.

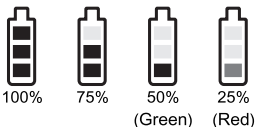

ACT-52HC :

1. Power On/Off:
 - (A) Slide up or down the Power Switch **7** to power on or off. The LCD screen **5** is lit once it's powered.
 - (B) "OFF..." appears during power off.

OFF...

- When the battery has less than 10% power remaining (0-bar displayed), it needs to be recharged. If the under-voltage condition continues, the screen will show "OFF..." and it will power off automatically.

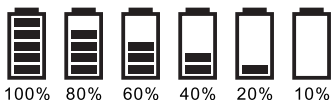

- Remove protection rear cover to expose MODE and SET buttons.

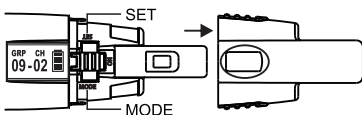

- Press the MODE button to access one of the 5 parameters below and press the SET button to activate parameters for changing.

- LCD Display:



- ⑫ Transmitter Functions
- ⑬ Transmitter Parameters
- ⑭ Transmitter Battery Display

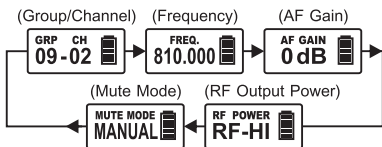

6. Under GROUP / CHANNEL and FREQUENCY modes, it will display the message in accordance with the receiver.



7. AF GAIN: Audio Gain

- (A) Adjusts audio level from 0dB to 6dB in 3dB step.
- (B) Press the MODE button to access the AF GAIN parameter. Press the SET button, the parameter value flashes. Press the SET button again and the values rotate by each press. Press the MODE button to save the selected value or the value will save automatically when it stops flashing.
- (C) The higher the gains, the lower the dynamic range for signal input and the greater the danger of unwanted noises and higher chances of feedback.
- (D) The default value of AF Gain is 0dB.

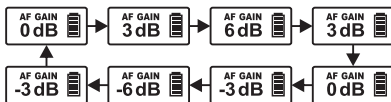

8. RF POWER: RF Power

- (A) Two parameter values: RF-HI and RF-LOW.
- (B) Press the MODE button to access the RF POWER parameter. Press the SET button, the parameter value flashes. Press the SET button again and the values rotate by each press. Press the MODE button to save the selected value or the value will save automatically when it stops flashing.



9. MUTE MODE: audio mute

- (A) Two parameters: MANUAL and DISABLE.
- (B) Press the MODE button to access the RF POWER parameter. Press the SET button, the parameter value flashes. Press the SET button again and the values rotate by each press. Press the MODE button to save the selected value or the value will save automatically when it stops flashing.
- (C) MANUAL: MUTE is controllable by pressing the external MUTE button.
- (D) DISABLE: Mute is disabled and cannot be muted in any method.



10. Error codes:

- (A) ERR no01→ Transmitter does not have the initial programmed data.
- (B) ERR no02→ (for test)RF circuitry failure, the frequency cannot be programmed.
- (C) ERR no03→ The frequency to be set exceeds the upper limit of the microphone. It cannot be synced, thus, no RF and audio transmission. Power on the microphone again to reset.
- (D) ERR no04→ The frequency to be set exceeds the lower limit of the transmitter. It cannot be synced, thus, no RF and audio transmission. Power on the microphone again to reset.

11. GROUP CHANNEL: The preset frequency of the receiver.

12. Displays "CHANNEL" only: User-defined frequency of receiver and needs to be changed via PC.

13. MUTE setting:

- (A) Press the MUTE button to enter mute status.
- (B) Press MODE and SET buttons to change other parameters, but it will return to MUTE mode after 5 seconds.
- (C) Press the MUTE button again to unmute.
- (D) "UNMUTE" only shows for 1 second and then goes back to the main display.
- (E) The MUTE button can work only under MANUAL mode.

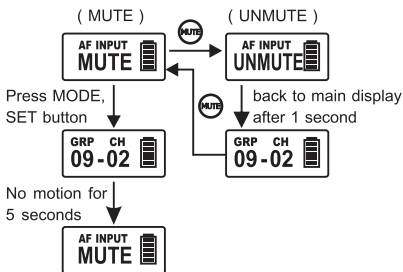

IV. Protection rear cover to prevent accidental power on/off

1. To prevent users from powering off the microphone accidentally, take out and reverse the protective rear cover.
2. We recommend the rear cover is installed during usage.

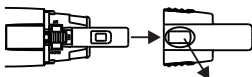

Power switch is exposed

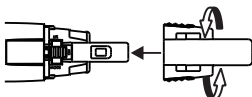

Power switch is covered after 180-degree reversal

V. Transmitter Battery Chargers (optional)

Transmitter(s) can be recharged by docking into a MP-8 charger.

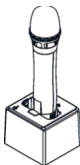

Handheld transmitter charging in MP-8

VI. Cautions

1. Turn off to save battery life when not in use. Remove the battery not use for an extended period of time.
2. To improve efficiency of transmitting antenna, do not cover the hands over the rear housing section.
3. To prevent degraded microphone sound quality, directionality and annoying feedback, do not cover the hands over microphone grill.
4. Correct posture of holding the handheld microphone is required because the distance between the microphone and the mouth will have a significant impact on the sensitivity and sound quality.
5. Keep the microphone grill clean and unblocked to enhance pick-up sound quality.
6. Refer to the actual product in the event of product description discrepancy.
7. Frequency range and maximum deviation comply with the regulations of different countries.
8. Spraying alcohol directly onto the condenser capsule module will cause severe damage and invalidate the warranty.



FCC

FCC Caution: To assure continued compliance, any changes or modifications not expressly approved by the party responsible for compliance could void the user's authority to operate this equipment. (Example - use only shielded interface cables when connecting to computer or peripheral devices).

This device complies with Part 15 of the FCC Rules. Operation is subject to the following two conditions:

- (1) This device may not cause harmful interference, and
- (2) This device must accept any interference received, including interference that may cause undesired operation.

This device complied with FCC radiation exposure limits as set forth for an uncontrolled environment. This device should be installed and operated so that its antenna(s) are not co-located or operating in conjunction with any other antenna or transmitter.

IC

This device complies with Industry Canada's RSSs. Operation is subject to the following two conditions:

- (1) This device may not cause interference; and
- (2) This device must accept any interference, including interference that may cause undesired operation of the device.

Le présent appareil est conforme aux CNR d'Industrie Canada applicables aux appareils radio. L'exploitation est autorisée aux deux conditions suivantes :

- (1) l'appareil ne doit pas produire de brouillage;
- (2) l'utilisateur de l'appareil doit accepter tout brouillage radioélectrique subi, même si le brouillage est susceptible d'en compromettre le fonctionnement.

Federal Communication Commission Interference Statement

This equipment has been tested and found to comply with the limits for a Class B digital device, pursuant to Part 15 of the FCC Rules. These limits are designed to provide reasonable protection against harmful interference in a residential installation.

This equipment generates, uses and can radiate radio frequency energy and, if not installed and used in accordance with the instructions, may cause harmful interference to radio communications. However, there is no guarantee that interference will not occur in a particular installation. If this equipment does cause harmful interference to radio or television reception, which can be determined by turning the equipment off and on, the user is encouraged to try to correct the interference by one of the following measures:

- Reorient or relocate the receiving antenna.
- Increase the separation between the equipment and receiver.
- Connect the equipment into an outlet on a circuit different from that to which the receiver is connected.
- Consult the dealer or an experienced radio/TV technician for help.

FCC Caution: To assure continued compliance, any changes or modifications not expressly approved by the party responsible for compliance could void the user's authority to operate this equipment. (Example - use only shielded interface cables when connecting to computer or peripheral devices).

FCC Radiation Exposure Statement

This equipment complies with FCC RF radiation exposure limits set forth for an uncontrolled environment.

This transmitter must not be co-located or operating in conjunction with any other antenna or transmitter.

This device complies with Part 15 of the FCC Rules. Operation is subject to the following two conditions:

- (1) This device may not cause harmful interference, and
- (2) This device must accept any interference received, including interference that may cause undesired operation.

Industry Canada Statement

This device complies with Industry Canada licence-exempt RSS standard.

Operation is subject to the following two conditions:

- (1) this device may not cause interference, and
- (2) this device must accept any interference, including interference that may cause undesired operation of the device.

Le présent appareil est conforme aux CNR d'Industrie Canada applicables aux appareils radio exempts de licence. L'exploitation est autorisée aux deux conditions suivantes : (1) l'appareil ne doit pas produire de brouillage, et (2) l'utilisateur de l'appareil doit accepter tout brouillage radioélectrique subi, même si le brouillage est susceptible d'en compromettre le fonctionnement.

IC Radiation Exposure Statement:

This equipment complies with IC RSS-102 radiation exposure limit set forth for an uncontrolled environment.

Cet équipement est conforme aux CNR-102 d'Industrie Canada.

MIPRO[®]
MICROPHONE PROFESSIONALS



All rights reserved. Do not copy or forward without prior approvals of MIPRO. Specifications and design subject to change without notice. YM 022/04

MIPRO Electronics Co., Ltd

Headquarters: No. 814, Beigang Rd., Chiayi City 600079, Taiwan
Tel : +886.5.238.0809 Fax : +886.5.238.0803
www.mipro.com.tw mipro@mipro.com.tw



2 CE6 17 C